



Baseplate Installation Instructions

BX3330

2007-10 Saturn Outlook Installation Instructions

Serial Number

Please read BOTH these Installation Instructions and the General Towing Instructions before attempting to install or operate this equipment.

1. Blue Ox® towing products and accessories are intended to be installed by Blue Ox® Dealers who are familiar with our products and have the equipment and knowledge to do “fit work.” When necessary, Blue Ox® Dealers can be found at www.blueox.com or by contacting our Customer Care Department at (402) 385-3051.
2. Many Blue Ox® baseplates are designed to use existing holes and hardware to mount the baseplate to the towed vehicle. Even though bolts are there, do not assume they are adequate for baseplate mounting. Always use hardware supplied in the hardware kit or existing hardware specified in the Baseplate Towing Installation Instructions.

Attachment Tab Height: 16 1/2”

Attachment Tab Width: 23”

Bolt Torque Specifications
Torque in Foot-Pounds for Metric Bolts

| Bolt Size | Grade 8.8 | Grade 10.9 |
|-----------|-----------|------------|
| 6MM | 6 | 8 |
| 8MM | 16 | 22 |
| 10MM | 31 | 40 |
| 12MM | 54 | 70 |
| 14MM | 89 | 117 |

Confirm the towability and pre-towing procedures for your vehicle with the owner’s manual or contact the vehicle’s manufacturer for specific towing procedures.

Bolt Torque Specifications
Torque in Foot-Pounds for Inch Bolts

| Bolt Size | Grade 5 | Grade 8 |
|-----------|---------|---------|
| 1/4” | 10 | 14 |
| 5/16” | 19 | 29 |
| 3/8” | 33 | 47 |
| 7/16” | 54 | 78 |
| 1/2” | 78 | 119 |
| 5/8” | 154 | 230 |



If the front of your vehicle looks different than this, call us at (402) 385-3051.

! WARNING

Failure to read and follow these instructions could result in separation of the towed vehicle from the tow bar, causing property damage, loss of towed vehicle, personal injury or death.

BX3330

2007-10 Saturn Outlook

Installation Instructions

Parts List

| Ref. No. | Qty. | Part # | Description |
|----------|------|----------|---|
| 1 | 1 | 61-6364 | Weldment, Baseplate, BX3330 |
| 2 | 4 | 201-0051 | 1/2-13 x 1 1/2" Hex Bolt, GRD. 5, ZP |
| 3 | 4 | 203-0012 | 1/2" Lock Washer, ZP |
| 4 | 4 | 61-4029 | Weldment, 1/2" Nut Wire, Common |
| 5 | 2 | 201-0979 | #12-14 x 1" Self Drilling Screw, ZP |
| 6 | 2 | 201-0192 | #10-32x1/2" Slot, Round Head Screw |
| 7 | 2 | 203-0054 | #10 Lock Washer |
| 8 | 2 | 202-0047 | #10-32 Hex Nut |
| 9 | 2 | 101-5822 | Adapter, 4 Way Connector |
| 10 | 2 | 62-3468 | Attachment, Assembly, SF/SB, 1 Hole |
| | 2 | 290-0437 | Cap Plug, Black (Not Shown) |
| | 2 | 229-0359 | Quicklink, 3/8", ZP (Not Shown) |
| | 2 | 226-0046 | Baseplate Safety Cable, 36" Class III (Not Shown) |
| E | 4 | | Existing Bolts |

Tools Required

Loctite® RED
 Phillips Screwdriver
 7MM Socket
 10MM Socket
 15MM Socket
 17/32" Drill Bit
 Reciprocating Saw
 Utility Knife

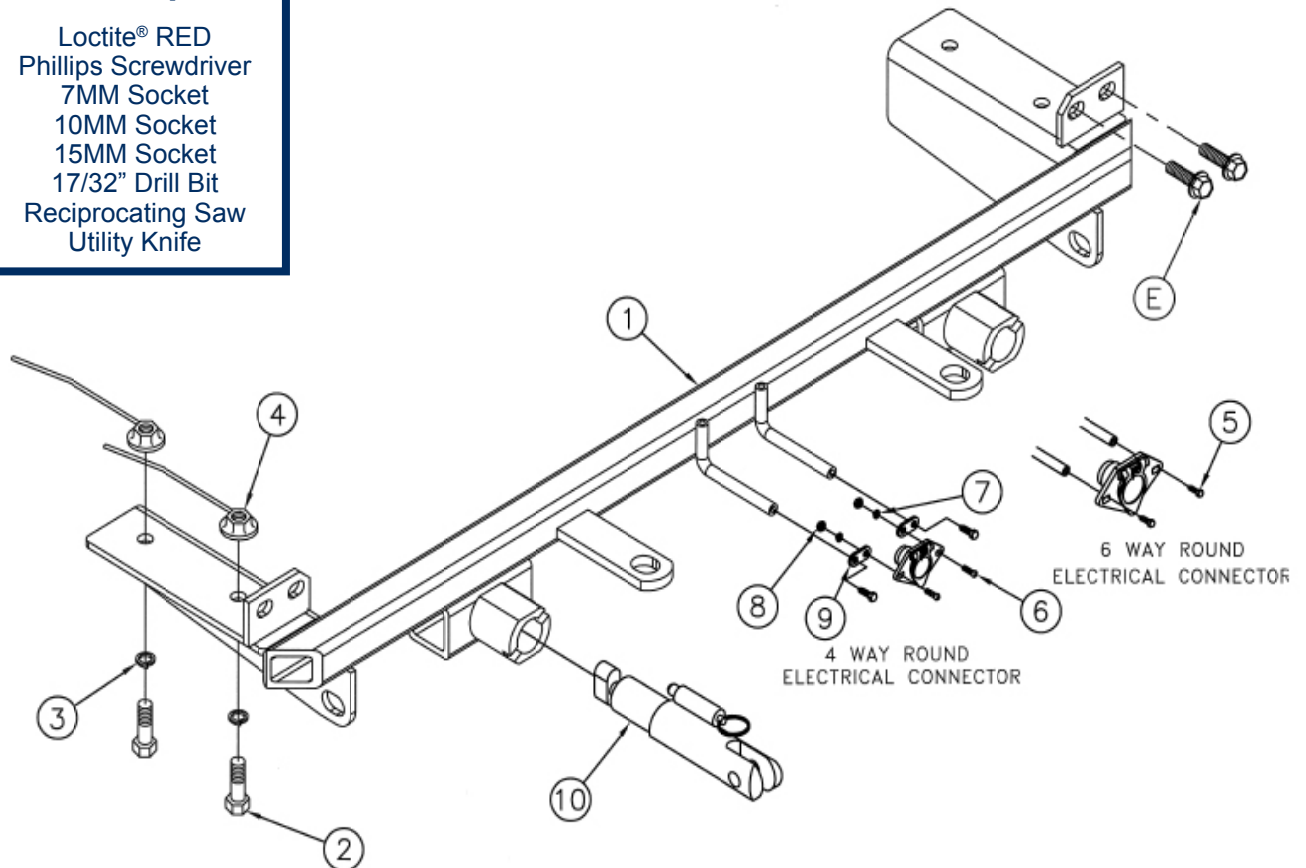

Important:

Use only genuine factory replacement parts on your baseplate. Do **NOT** substitute homemade or non-typical parts. If a bolt is lost or in need of replacement, for your safety and the preservation of your baseplate, be sure to use a replacement bolt of the same grade (In most cases it will be Grade 5, please reference the parts list above). Replacement parts may be ordered through your nearest Blue Ox® Dealer or Distributor. Failing to follow and/or altering these installation instructions in either installation or required equipment will void the manufacturer's warranty.

BX3330

2007-10 Saturn Outlook

Installation Instructions

Attachment Tabs: Due to the design of the removable tabs, the RangeFinder II, Adventurer and Ambassador tow bars can not be used. Adapters, except the BX8833 and BX88151, can be used with this baseplate.

Installation Notes: The fascia is removed and reinstalled during installation of the baseplate. Drilling is required. Trimming of the fascia is required.

The dimensional variations between otherwise identical vehicles can be considerable. While the baseplate was designed for easy installation, it may be necessary to tailor the baseplate slightly to compensate for auto manufacturer's tolerances. These minor adjustments may include filing a hole slightly, bending electrical rods or bending end plates.

The BX8869 Bulb and Socket Wiring Kit is recommended for this vehicle.



Possible location for Bulb and Socket Wiring Kit (BX8869)

Handling of some cosmetic parts when installing this product may require the use of protective covers, rags, specialty tools, etc. to prevent damage.

Installation Instructions:



1. Using a flat screwdriver, remove 4 push pins from the flat plastic piece on top. Do this to both sides of the vehicle. Set push pins aside to be reinstalled later.

Do not use the towed vehicle for storing luggage, equipment, etc. This may cause you to exceed the towing capacity of the tow bar, baseplate, and its accessories.

BX3330

2007-10 Saturn Outlook

Installation Instructions

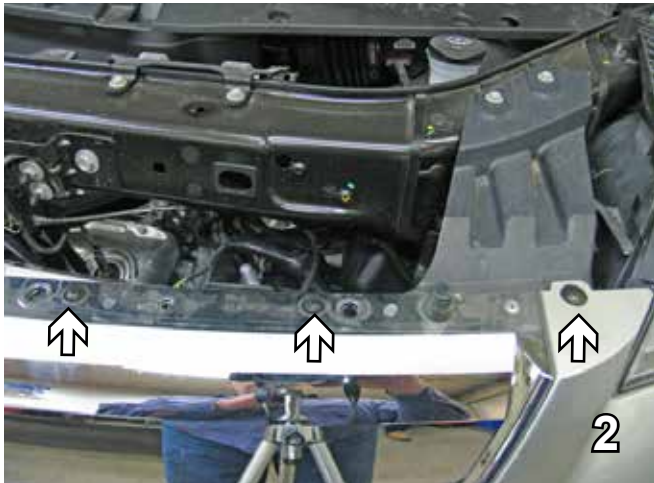

2. Using a phillips screwdriver, remove two phillips screws on top of the fascia and using a flat screwdriver, remove one pushpin from the top outside edge. Do this to both sides of the vehicle. Set screws and push pins aside to be reinstalled later.

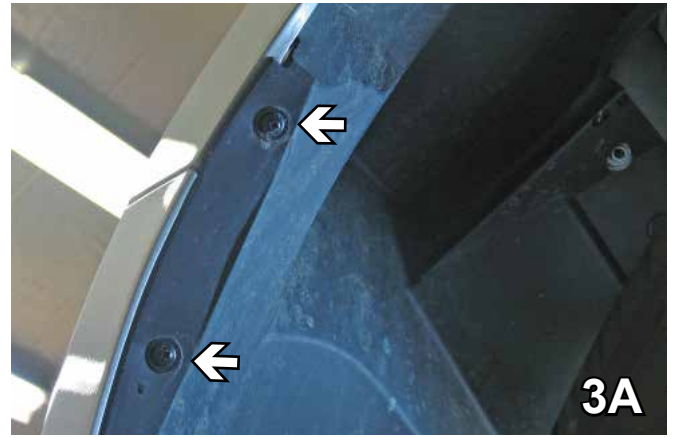

3. Using a phillips screwdriver, remove four phillips screws just forward of the front tire, on the wheel well. Set screws aside to be reinstalled later. Do this to both sides of the vehicle.



4. Using a phillips screwdriver, remove two screws from just forward of the front tire underneath. Set screws aside to be reinstalled later. Do this to both sides of the vehicle.



5. After removing the screws in Step 1 and 2, pull plastic back to get to a bolt. Using a 7MM socket, remove bolt and set aside to be reinstalled later. Do this to both sides of the vehicle.

BX3330

2007-10 Saturn Outlook

Installation Instructions



6. Using a 10MM socket, remove a bolt from the brace for the fog light. In the picture above, the bolt is hidden slightly (see white arrow). Set bolt aside to be reinstalled later. Do this to both sides of the vehicle. The fascia is then ready to be removed from the vehicle and carefully set aside to be reinstalled later.



7. Using a flat screwdriver, remove pushpin (see white arrow) and then using a utility knife, cut along dashed line shown in the photo above (see grey arrow). The plastic piece will not be reinstalled and can be discarded. Do this to both sides of the vehicle.

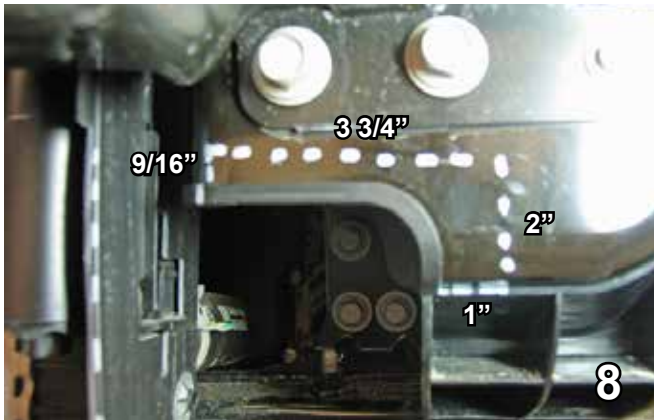

8. Mark and cut out frame according to the photo above, using a reciprocating saw. Do this to both sides of the vehicle.

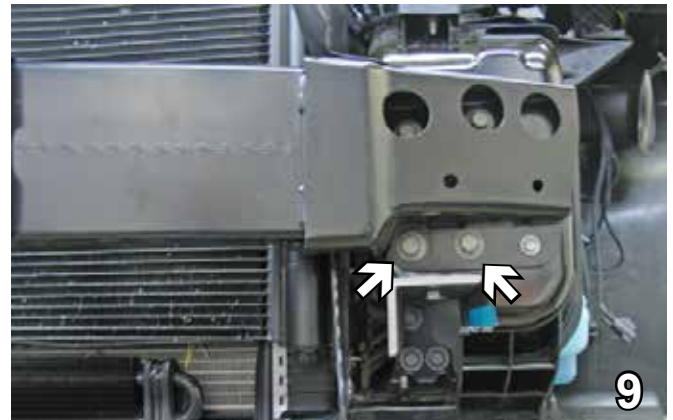

9. Using a 15MM socket, remove two bolts from the front of the bumper. Set bolts aside to be reinstalled later. Do this to both sides of the vehicle.

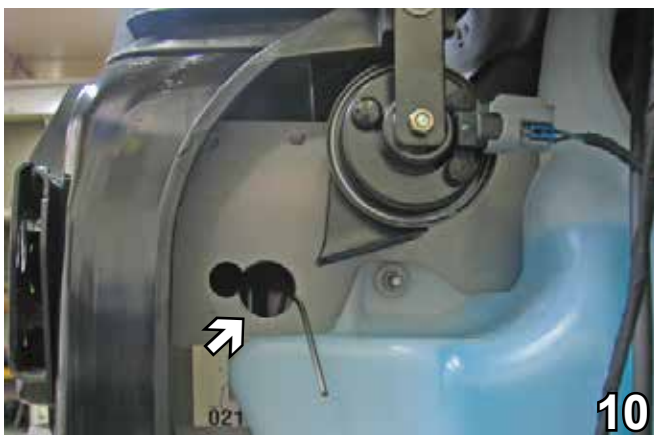

10. Drill a 1 1/4" hole into the frame, so the nut plates can go through. Do this to both sides of the vehicle.

When using power drills, be aware of the dangers of torque and drill bit length.

BX3330

2007-10 Saturn Outlook

Installation Instructions

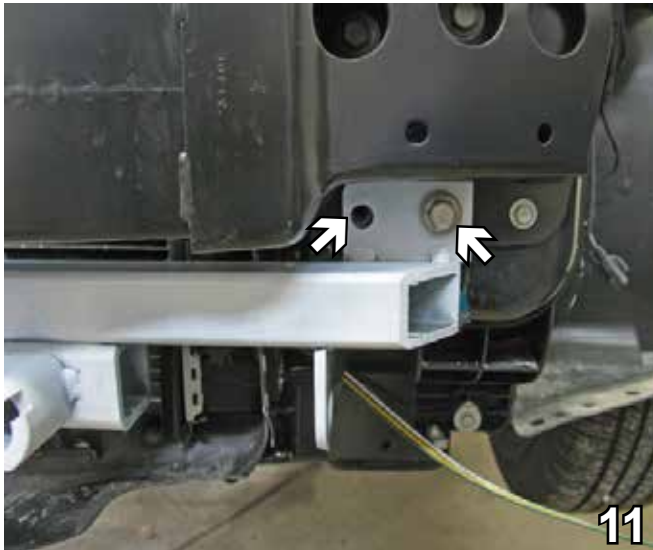

11. Slide baseplate up, so it matches up with the existing holes of the bumper. Insert the existing bolts from the bumper and tighten them down with a 15MM socket so they are snug. Do this to both sides of the vehicle.



12. Using the baseplate as a template, drill the two bottom holes into the frame with a 17/32" drill bit. Insert the 1/2" nut plates into the frame and align with drilled holes. Insert a 1/2-13x1 1/2" hex bolt and 1/2" lock washer into each hole and tighten down with a 3/4" socket. Do this to both sides of the vehicle.



13. Attach permanent baseplate safety cables to the convenience link on the baseplate (see photo 12A). Photo 12B shows recommended installation of the cables to frame of vehicle. If vehicle has additional options (not shown above) which interfere with mounting permanent baseplate safety cables, secure the cables to a solid piece of the vehicle frame as described in instructions included with the permanent baseplate safety cables.

BE SURE TO USE LOCTITE® RED ON ALL BOLTS BEFORE TIGHTENING. TIGHTEN ALL BOLTS ACCORDING TO THE TORQUE CHART ON THE FRONT PAGE OF THESE INSTRUCTIONS OR ON PAGE 3 OF THE BASEPLATE TOWING GENERAL INSTRUCTIONS.



14. Align the fascia to its original position, and using a hack saw knife, trim out the opening in the grille for the attachment tabs, using the photo above as a template. Do this to both sides of the vehicle.

Be sure that ALL electrical connections are plugged in properly and functioning BEFORE installing the fascia.

BX3330

2007-10 Saturn Outlook

Installation Instructions

Install the tow bar and safety cables according to the instructions provided in their packages. When demonstrating this to the customer, be sure to include all the contents and packages.

Do **NOT** substitute other devices if the tow bar pins and clips are misplaced.

DEALER or INSTALLER:
Be certain the user receives the instruction sheets for their products.



Shown without removable tabs installed.



Shown with removable tabs installed.

If the baseplate is in an accident, it must be replaced. **DO NOT** use it again! An accident can cause unseen damage and using it again could result in more damage or serious injury. **DO NOT** use the baseplate if it is damaged or missing parts.

CUSTOMER SERVICE COMMITMENT

Blue Ox is committed to providing you with exceptional customer care throughout your lifetime with our products. Our team is here to assist you with any questions you may have regarding the performance of your product. Simply call 1-800-228-9289 and you can speak with our customer care team.

Additionally, please visit our website to see which rallies our Destination America team will be attending. For a nominal fee, our service technician will service your towing system to ensure it's in proper working condition. Also, as a commitment to our customers, should you visit our factory you can stay at our full service Blue Ox campground at no charge along with enjoying a factory tour.

Again, thank you for being our customer and for the confidence you have shown in the performance of our products. It is because of customers like you we enjoy the success we have today.

Do not use the towed vehicle for storing luggage, equipment, etc. This may cause you to exceed the towing capacity of the tow bar, baseplate, and its accessories.



© 2011 Blue Ox
One Mill Road, Industrial Park
Pender, Nebraska 68047
Phone: (402) 385-3051 • Fax: (402) 385-3360
www.blueox.com

General Information

1. Ensure that your product(s) are registered online at www.blueox.com. It is crucial to register your product(s) so that you may be alerted of product offerings, updates, upgrades, maintenance and safety bulletins, and/or recalls.
2. **It is the owner's responsibility to inspect all towing equipment for cracked welds, missing or worn parts and loose bolts before each towing trip.** Be sure to use Loctite® Red on all bolts and tighten to the recommended specifications.
3. **It is the owner's responsibility to hook up all towing equipment per manufacturer's instructions/recommendations.**
4. Remove the attachment tabs when not in use (if applicable).

Notice To Baseplate Installer

1. It is YOUR responsibility to watch for:

- Oil cooler and air conditioner lines
- Electrical wires and hoses
- Missing parts or attaching points on the frame

** If the baseplate is improperly installed and is against a wire or hose, it could cause fluid leaks or electrical shorts some time after the actual baseplate installation.

Permanent Baseplate Safety Cable Installation

Permanent baseplate safety cables are strongly recommended when towing a vehicle with a tow bar. The principle function of the permanent baseplate safety cables is to prevent the towed vehicle from breaking loose in the event the connection between the frame of the towed vehicle and the baseplate fails or becomes disconnected. The cables must be connected from the baseplate to the frame rail or cross member of the vehicle's frame. The illustrations below show the possible arrangements recommended by Blue Ox®. Each permanent baseplate safety cable must have an adequate weight rating for the towing system. The weight rating of the two (2) cables together will not qualify.

Do not mount the permanent baseplate safety cables against wires, hoses or brake lines.

These permanent baseplate safety cables should remain installed as long as the baseplate is installed on the vehicle. Permanent baseplate safety cables are to be used in conjunction with, and NOT a replacement for legally required safety cables attaching the towed vehicle to the towing vehicle.

OPTION #1

Permanent Baseplate Safety Cables to Cross Member or Frame of Towed Vehicle.



OPTION #2

Permanent Baseplate Safety Cables to Cross Member or Frame of Towed Vehicle.

